

## Miniatur-Reflexlichtschranken Miniature Light Reflection Switches

SFH 900

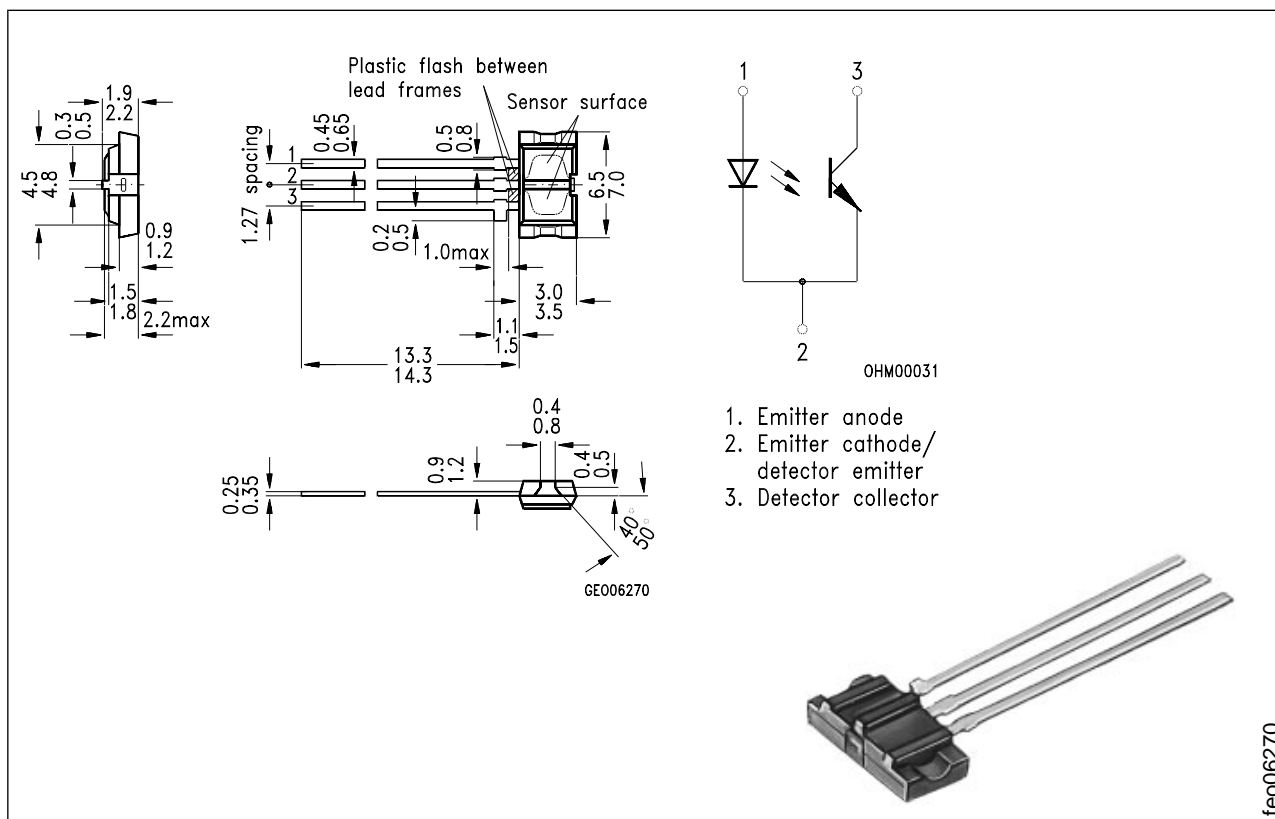

Maße in mm, wenn nicht anders angegeben/Dimensions in mm, unless otherwise specified.

### Wesentliche Merkmale

- Reflexlichtschranken für den Nahbereich (bis 5 mm Abstand)
- IR-GaAs-Lumineszenzdiode
- Si-NPN-Fototransistor
- Flaches Kunststoffgehäuse
- Tageslichtsperrfilter
- Hoher Kollektor-Emitter-Strom  
0.25 ...  $\geq$  1.0 mA
- Geringe Sättigungsspannung
- Kein Übersprechen

### Anwendungen

- Positionsmelder
- Endabschalter
- Drehzahlüberwachung
- Bewegungssensor

### Features

- Designed for short distances up to 5 mm
- GaAs infrared emitter
- Silicon NPN phototransistor detector
- Flat plastic package
- Daylight filter against undesired light effects
- High collector-emitter current  
0.25 ...  $\geq$  1.0 mA
- Low saturation voltage
- No cross talk

### Applications

- Position reporting
- Devices and end position switches
- Speed monitoring
- Various types of motion transmitters

Typ Type	Bestellnummer Ordering Code
SFH 900	Q62702-P1187
SFH 900-1 <sup>1)</sup>	Q62702-P935
SFH 900-2	Q62703-P141
SFH 900-3	Q62703-P1088
SFH 900-4 <sup>1)</sup>	Q62703-P1087

- 1) Nur auf Anfrage lieferbar.  
1) Available only on request.

### Grenzwerte ( $T_A = 40\text{ °C}$ ) Maximum Ratings

Bezeichnung Description	Symbol Symbol	Wert Value	Einheit Unit
----------------------------	------------------	---------------	-----------------

#### Sender (IR-GaAs-Lumineszenzdiode) Emitter (GaAs infrared diode)

Sperrspannung Reverse voltage	$V_R$	6	V
Vorwärtsstrom Forward current	$I_F$	50	mA
Vorwärtsstoßstrom, $t_p \leq 10\ \mu\text{s}$ Surge current	$I_{FSM}$	1.5	A
Verlustleistung Power dissipation	$P_{tot}$	80	mW

#### Empfänger (Si-Fototransistor) Detector (silicon phototransistor)

Kollektor-Emitter-Sperrspannung Collector-emitter voltage	$V_{CEO}$	30	V
Emitter-Kollektor-Sperrspannung Emitter-collector voltage	$V_{ECO}$	7	V
Kollektorstrom Collector current	$I_C$	10	mA
Verlustleistung Total power dissipation	$P_{tot}$	100	mW

Bezeichnung Description	Symbol Symbol	Wert Value	Einheit Unit
<b>Reflexlichtschranke</b> <b>Light reflection switch</b>			
Lagertemperatur Storage temperature range	$T_{\text{stg}}$	- 40 ... + 85	°C
Umgebungstemperatur Ambient temperature range	$T_A$	- 40 ... + 85	°C
Sperrschichttemperatur Junction temperature range	$T_j$	100	°C
Löttemperatur (Lötstelle $\geq 3$ mm vom Gehäuse entfernt bei Lötzeit $t \leq 3$ s) Soldering temperature (Dip soldering time $t \leq 3$ s at $\geq 3$ mm from package) mit Wärmeabführung vom Gehäuse with heat sink between case and soldering	$T_S$  $T_S$	235  260	°C  °C
Verlustleistung Total power dissipation	$P_{\text{tot}}$	150	mW

### Kennwerte ( $T_A = 25$ °C)

#### Characteristics

Bezeichnung Description	Symbol Symbol	Wert Value	Einheit Unit
<b>Sender</b> (IR-GaAs-Lumineszenzdiode) <b>Emitter</b> (GaAs infrared diode)			
Durchlaßspannung Forward voltage $I_F = 50$ mA	$V_F$	1.25 ( $\leq 1.65$ )	V
Durchbruchspannung Breakdown voltage $I_R = 10$ $\mu$ A	$V_{\text{BR}}$	$\geq 6$	V
Sperrstrom Reverse current $V_R = 6$ V	$I_R$	0.01 ( $\leq 10$ )	$\mu$ A
Kapazität Capacitance $V_R = 0$ V, $f = 1$ MHz	$C_O$	40	pF
Wärmewiderstand Thermal resistance	$R_{\text{thJA}}$	750	K/W

**Kennwerte** ( $T_A = 25\text{ °C}$ )

**Characteristics**

Bezeichnung Description	Symbol Symbol	Wert Value	Einheit Unit
----------------------------	------------------	---------------	-----------------

**Empfänger (Si-Fototransistor)**

**Detector (silicon phototransistor)**

Kapazität Capacitance $V_{CE} = 5\text{ V}, f = 1\text{ MHz}$	$C_{CE}$	11	pF
Kollektor-Emitter-Reststrom Collector-emitter leakage current $V_{CE} = 10\text{ V}$	$I_{CEO}$	20 ( $\leq 200$ )	nA
Fotostrom (Fremdlichtempfindlichkeit) Photocurrent (outside light density) $V_{CE} = 5\text{ V}, E_V = 1000\text{ Lx}$	$I_P$	3.5	mA
Wärmewiderstand Thermal resistance	$R_{thJA}$	600	mW

**Reflexlichtschranke**

**Light Reflection Switch**

Kollektor-Emitterstrom Collector-emitter current Kodak neutral white test card, 90% reflexion $I_F = 10\text{ mA}; V_{CE} = 5\text{ V}; d = 1\text{ mm}$ SFH 900 SFH 900-1 <sup>1)</sup> SFH 900-2 SFH 900-3 SFH 900-4 <sup>1)</sup>	$I_{CE}$ $I_{CE}$ $I_{CE}$ $I_{CE}$ $I_{CE}$	> 0.25 0.25 ... 0.50 0.40 ... 0.80 0.63 ... 1.25 $\geq 1.0$	mA mA mA mA mA
Kollektor-Emitter-Sättigungsspannung Collector-emitter saturation voltage Kodak neutral white test card, 90% reflexion $I_F = 10\text{ mA}; d = 1\text{ mm};$ SFH 900, $I_C = 85\text{ }\mu\text{A}$ SFH 900-1 <sup>1)</sup> , $I_C = 85\text{ }\mu\text{A}$ SFH 900-2, $I_C = 135\text{ }\mu\text{A}$ SFH 900-3, $I_C = 215\text{ }\mu\text{A}$ SFH 900-4 <sup>1)</sup> , $I_C = 335\text{ }\mu\text{A}$	$V_{CE\text{ sat}}$ $V_{CE\text{ sat}}$ $V_{CE\text{ sat}}$ $V_{CE\text{ sat}}$ $V_{CE\text{ sat}}$	0.2 ( $\leq 0.6$ ) 0.2 ( $\leq 0.6$ ) 0.2 ( $\leq 0.6$ ) 0.2 ( $\leq 0.6$ ) 0.2 ( $\leq 0.6$ )	V V V V V

<sup>1)</sup> Nur auf Anfrage lieferbar.  
<sup>1)</sup> Available only on request.

**Schaltzeiten** ( $T_A = 25\text{ °C}$ ,  $V_{CC} = 5\text{ V}$ ,  $I_C = 1\text{ mA}^{1)}$ ,  $R_L = 1\text{ k}\Omega$ )  
**Switching Times**

Bezeichnung Description	Symbol Symbol	Wert Value	Einheit Unit
Einschaltzeit Turn-on time	$t_{\text{ein}}$ $t_{\text{on}}$	65	$\mu\text{s}$
Anstiegszeit Rise time	$t_r$	50	$\mu\text{s}$
Ausschaltzeit Turn-off time	$t_{\text{aus}}$ $t_{\text{off}}$	55	$\mu\text{s}$
Abfallzeit Fall time	$t_f$	50	$\mu\text{s}$

- 1)  $I_C$  eingestellt über den Durchlaßstrom der Sendediode, den Reflexionsgrad und den Abstand des Reflektors vom Bauteil (d)  
 1)  $I_C$  as a function of the forward current of the emitting diode, the degree of reflection and the distance between reflector and component (d)

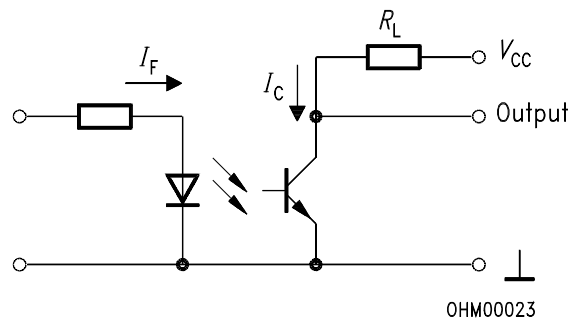
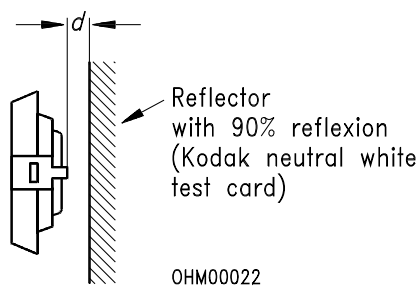

**Output characteristics (typ.)**  $I_C = f(V_{CE})$   
 spacing to reflector:  $d = 1\text{ mm}$ ,  
 90% reflection,  $T_A = 25\text{ °C}$

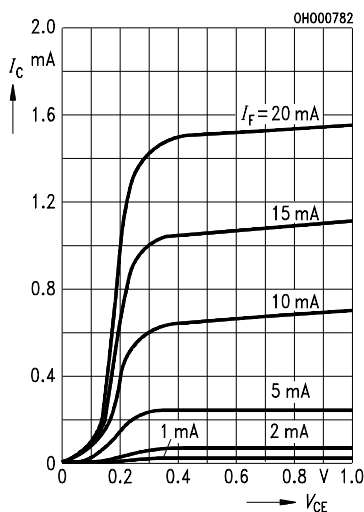

**Transistor capacitance (typ.)**  
 $C_{CE} = f(V_{CE})$ ,  $T_A = 25\text{ °C}$ ,  $f = 1\text{ MHz}$

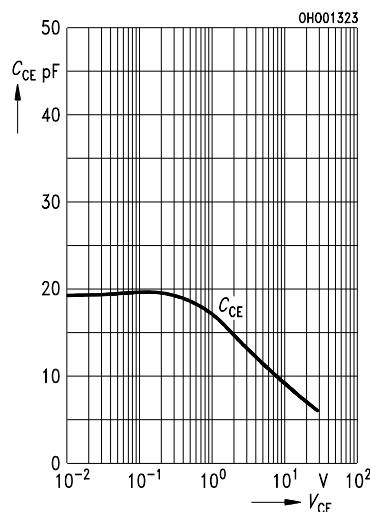

**Collector current**  $\frac{I_C}{I_{Cmax}} = f(d)$

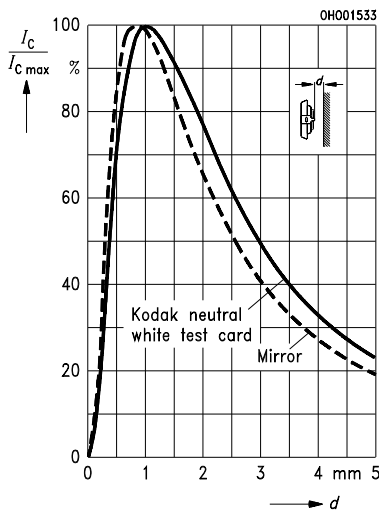

**Forward voltage (typ.) of the diode**  
 $V_F = f(I_F)$

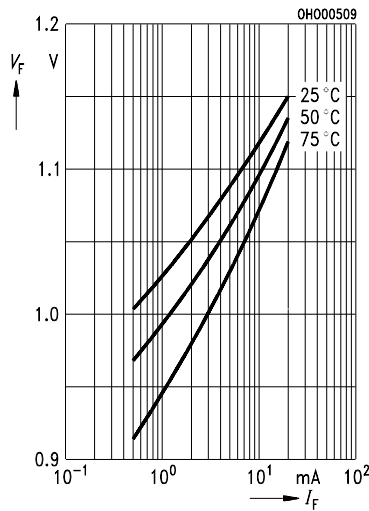

**Max. permissible forward current**  
 $I_F = f(T_A)$

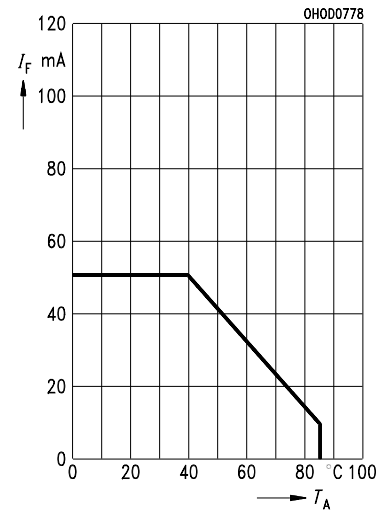

**Permissible power dissipation for diode and transistor**

$P_{tot} = f(T_A)$

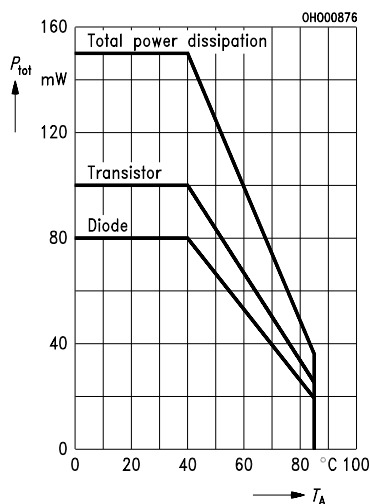

**Permissible pulse handling capability**

$I_F = f(t_p)$ ,  $D = \text{parameter}$ ,  $T_A = 25\text{ °C}$

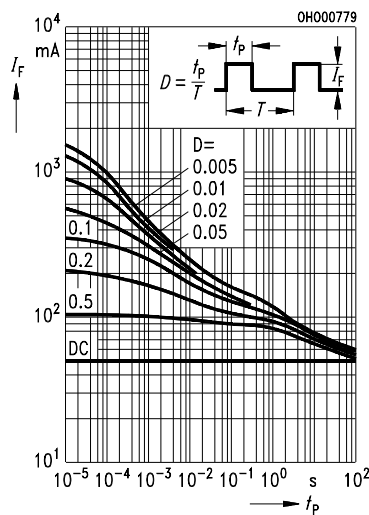

**Switching characteristics**

$t = f(R_L)$ ,  $T_A = 25\text{ °C}$ ,  $I_F = 10\text{ mA}$

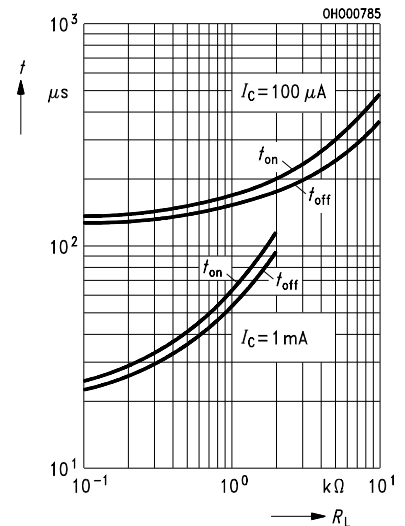

**Relative spectral emission of emitter (GaAs) and detector (Si)**

Emitter:  $I_{rel} = f(\lambda)$ , Detector:  $S_{rel} = f(\lambda)$

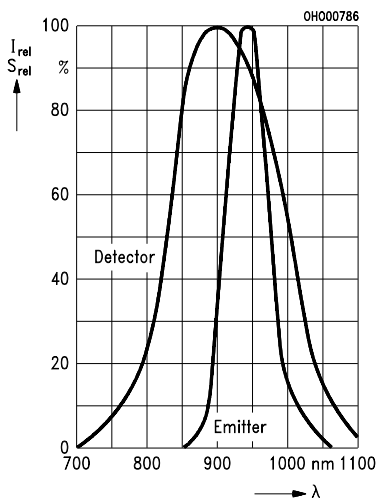

**Collector current, spacing d to reflector = 1 mm, 90% reflection**

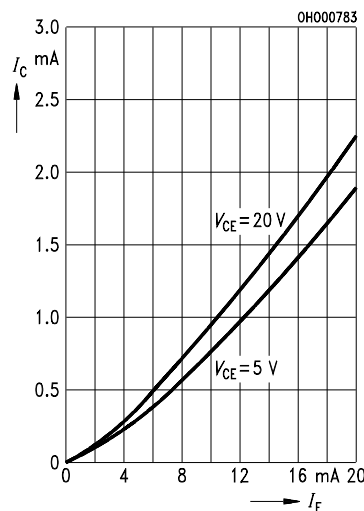

**Output characteristics,  $I_C = f(V_{CE})$**

spacing to reflector:  $d = 1\text{ mm}$ , 90% reflection,  $T_A = 25\text{ °C}$

